

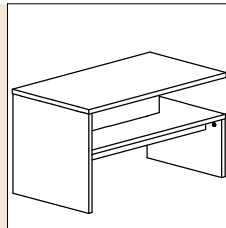

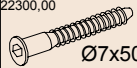

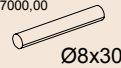

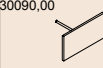



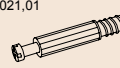





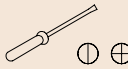

KS
KS-304-00
 900*500*500

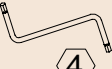

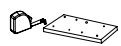
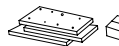

22300.00  Ø7x50	27000.00  Ø8x30	30090.00 	70013.01 	70021.01 		34950.00 
A 3x	B 10x	C 4x	D 13x	E 13x	F 2x	G 11x

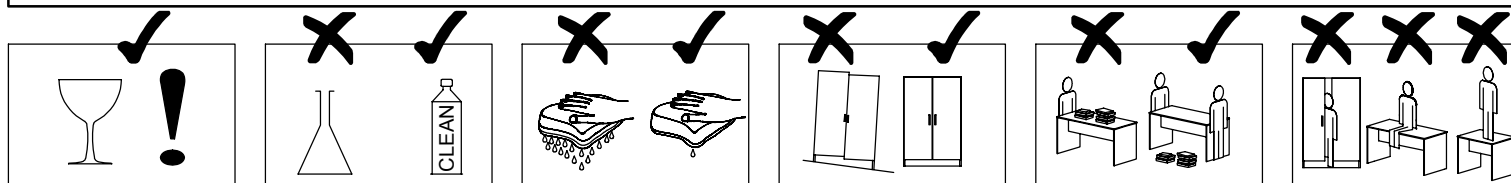
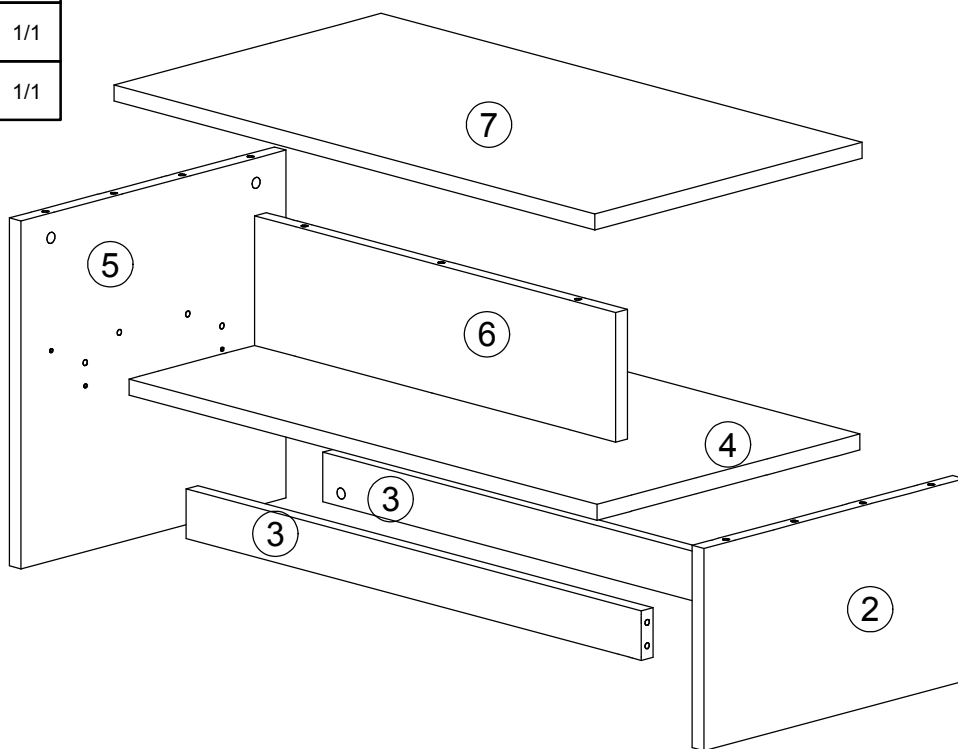

	 80min			 ≤ 0,5 kg	 3m	 600 mm	 4
--	--	---	---	---	---	--	--

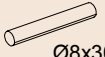
ID	ID	Icon	Dimensions	Qty	Ratio
08397	2		278*488*22	1x	1/1
08398	3		852*68*22	2x	1/1
08399	4		876*492*22	1x	1/1
08400	5		478*496*22	1x	1/1
08401	6		676*178*22	1x	1/1
08402	7		900*500*22	1x	1/1

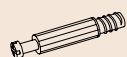

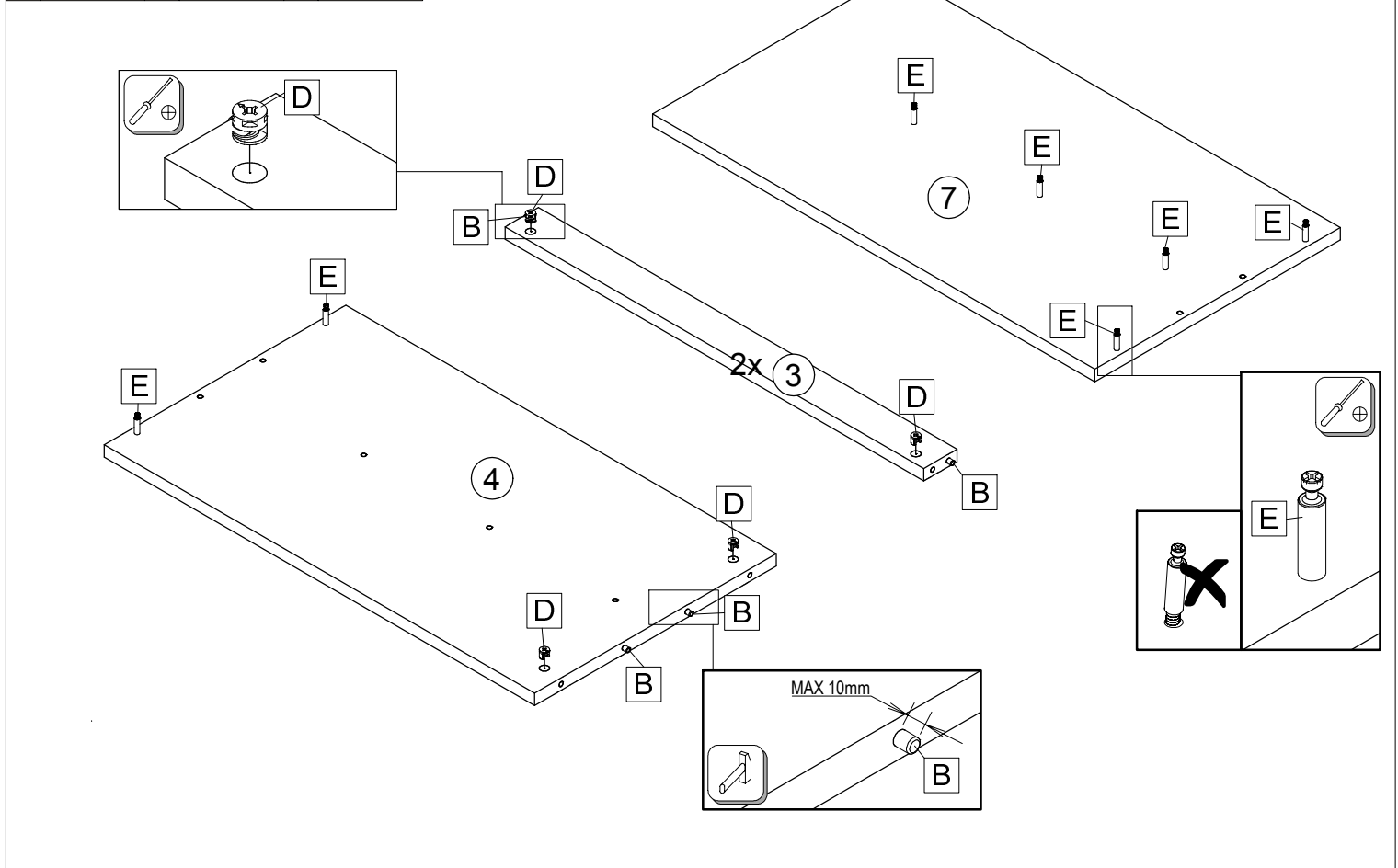
		
Ø8x30	3x2	
B 6x	D 6x	E 7x

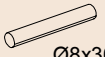

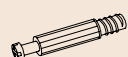
			
Ø8x30		3x2	
B 4x	C 4x	D 7x	E 6x

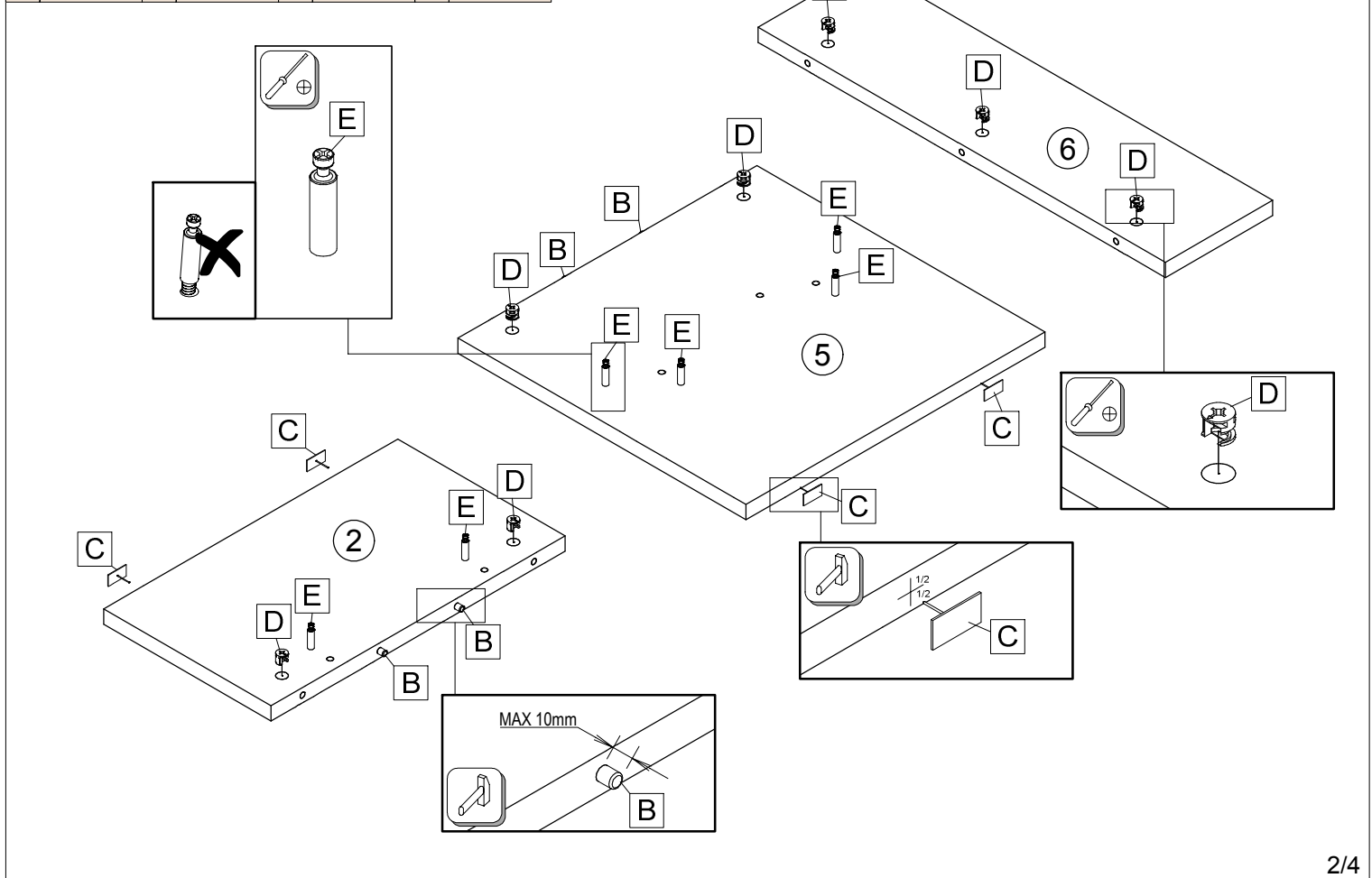

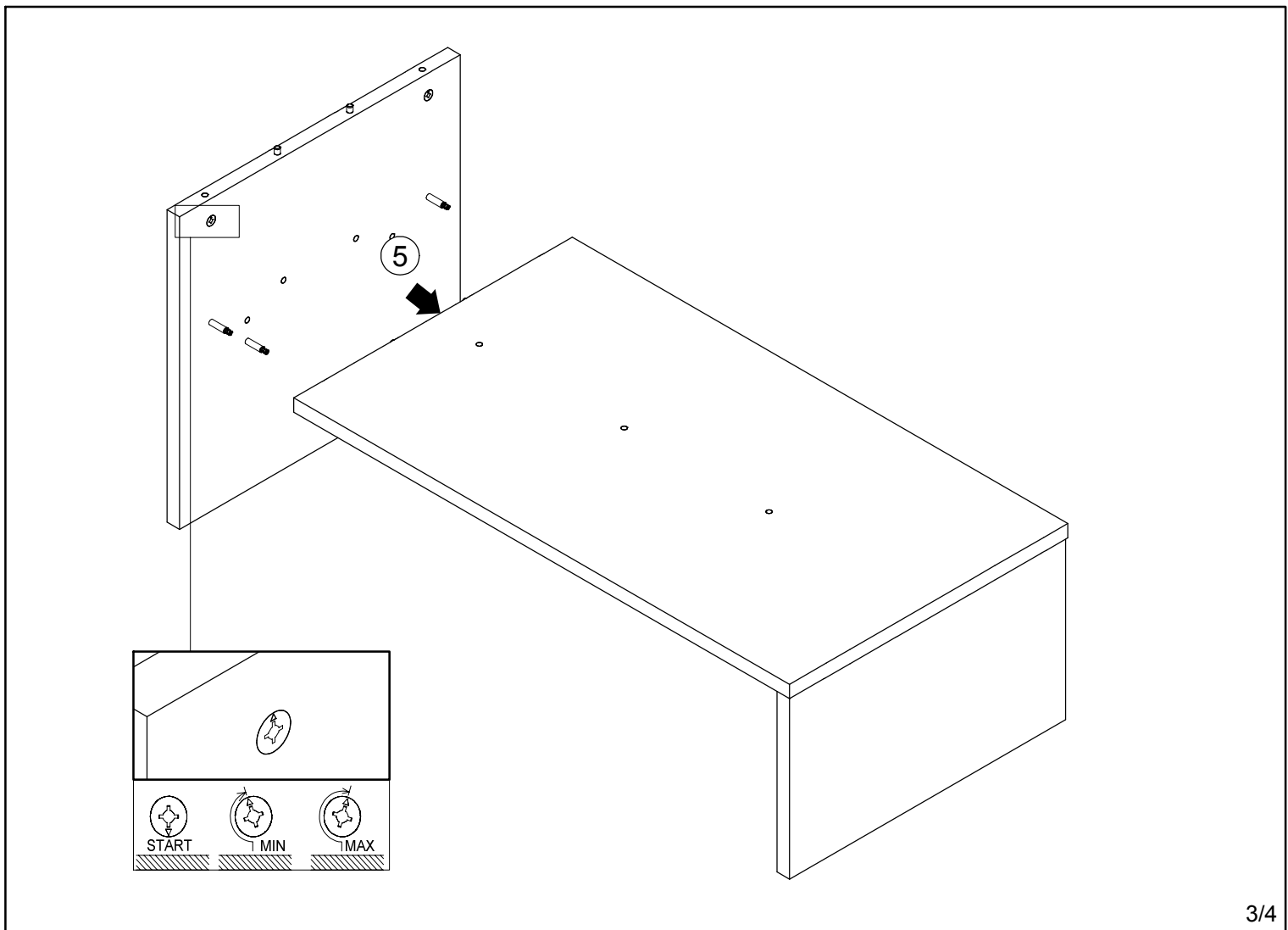
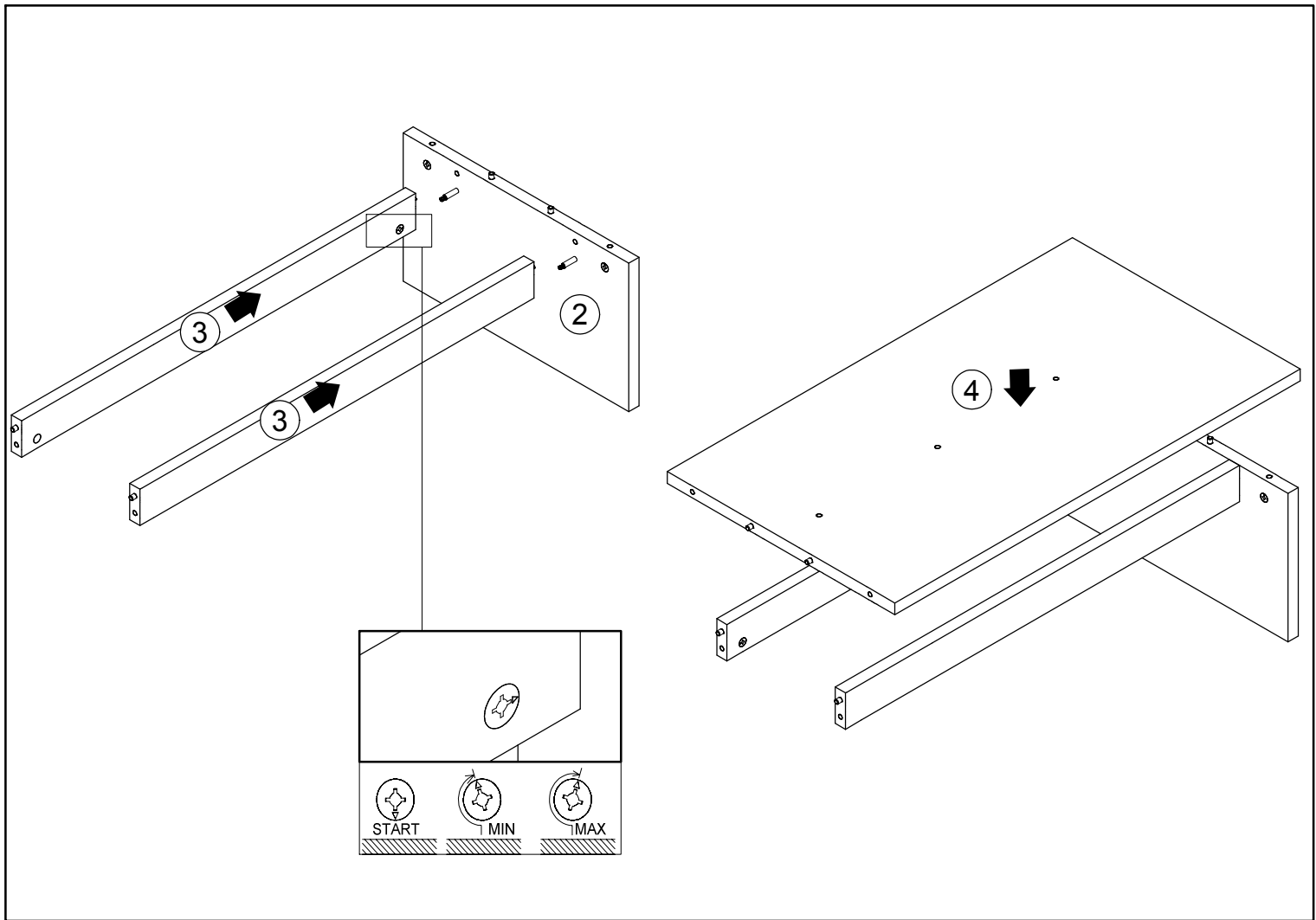

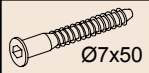

A 3x

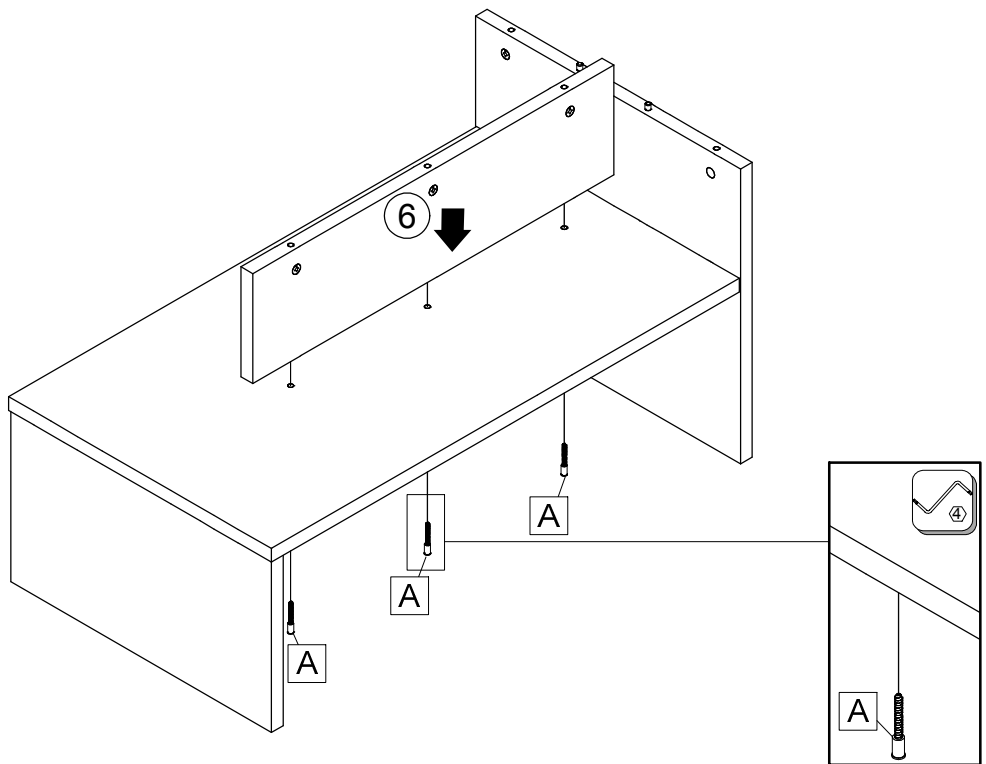

	F 2x		G 11x
--	------	--	-------

